

1 BALCONY DETAIL AT UNIT
1/2" = 1'-0"

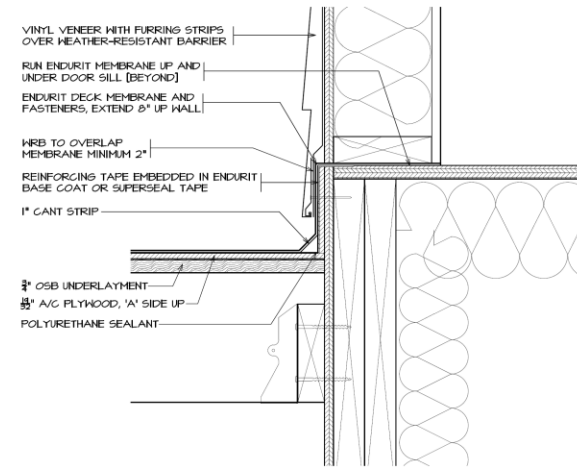

2 BALCONY DETAIL AT WALL
3/4" = 1'-0"

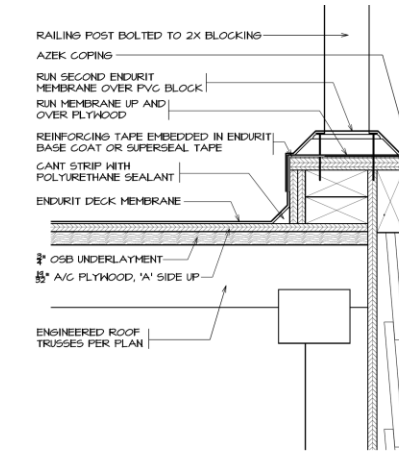

3 ROOF EDGE DETAIL
3/4" = 1'-0"

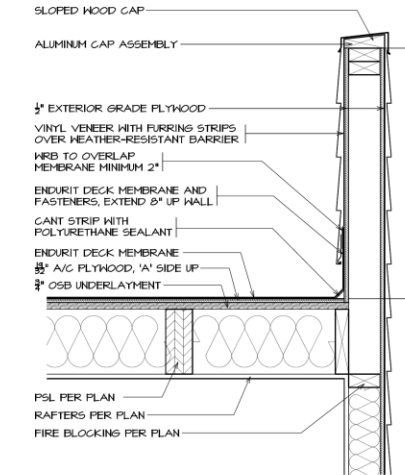

4 PARAPET DETAIL AT FRONT
1/2" = 1'-0"

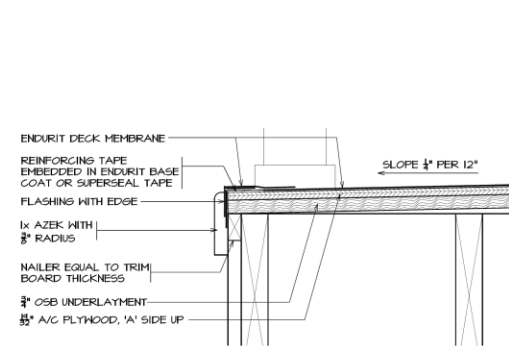

5 BALCONY DETAIL AT EDGE
3/4" = 1'-0"

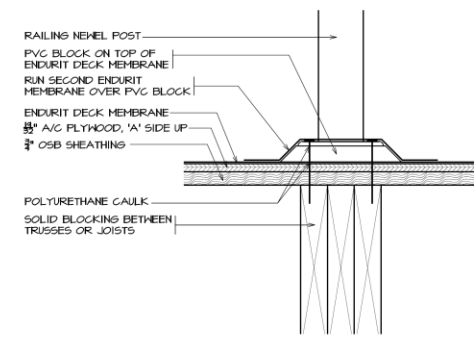

6 RAILING ATTACHMENT DETAIL
3/4" = 1'-0"

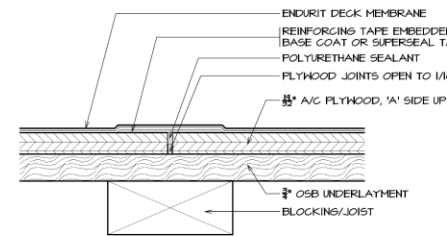

7 PLYWOOD JOINT
3/4" = 1'-0"

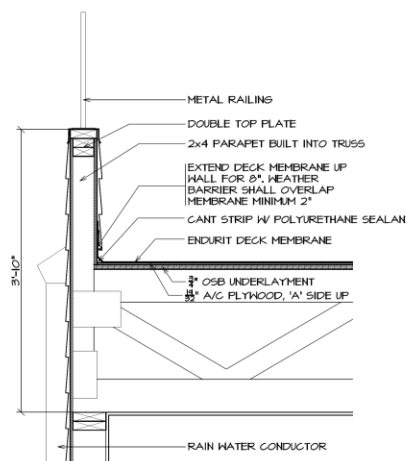

8 PARAPET DETAIL AT REAR
1" = 1'-0"

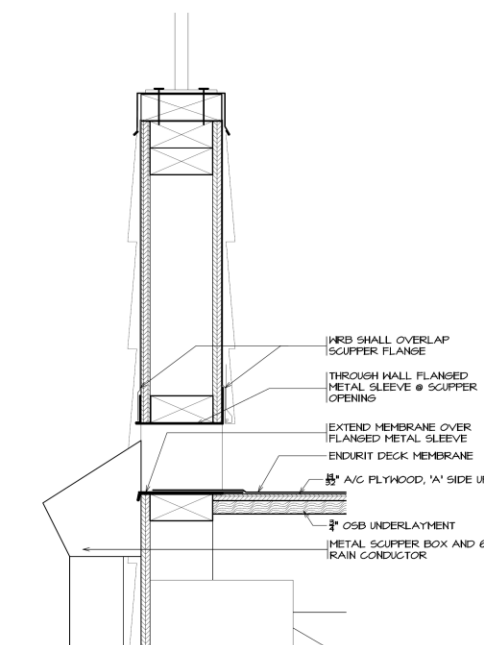

9 DETAIL AT SCUPPER
3/4" = 1'-0"

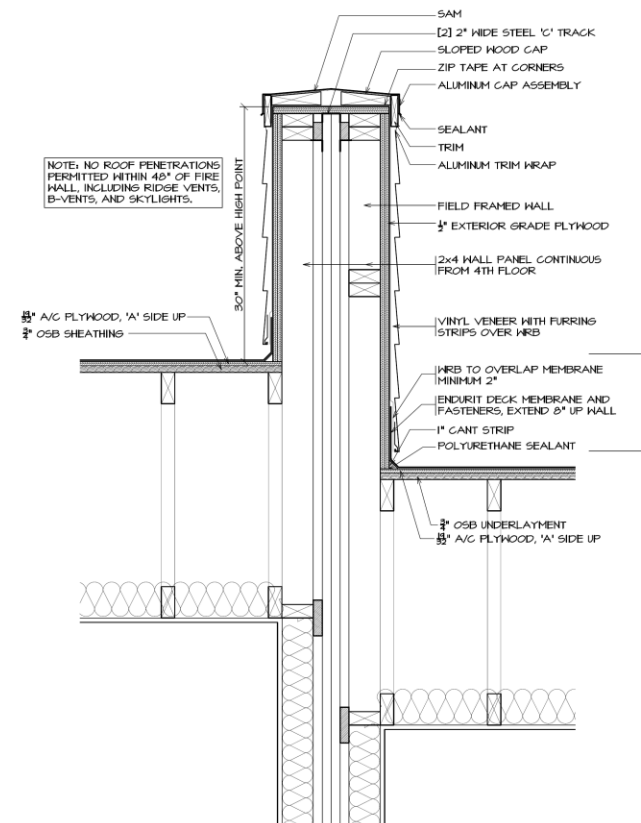

10 ROOF PARAPET WALL BETWEEN UNITS
1/2" = 1'-0"

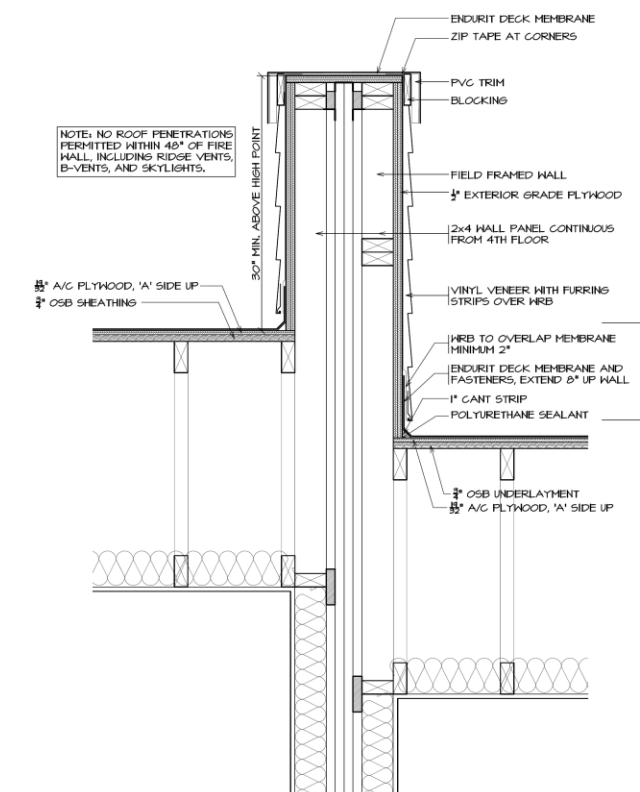

11 ROOF PARAPET WALL BETWEEN UNITS
1/2" = 1'-0"